

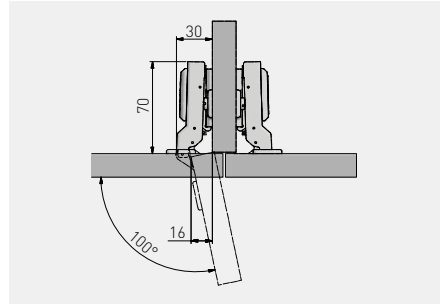





Zawias hydrauliczny ECHC z regulacją mimośrodową, bliźniaczy
 Hydraulic cup hinge ECHC with eccentric adjustment, twin overlay door
 Гидравлическая петля ЕСНС с эксцентриком, полунакладная



| | | | | | |
|---|---|---|---|---|---|
|  |  |  |  |  |  |
| ZM-ECHC08-3DBE0 | H=0 | x 4 | — | nikiel nickel никель | stal steel сталь |

